

# Agilent 8474B/C/E Coaxial GaAs Microwave Detectors

0.01 to 50 GHz  
Data Sheet



## Features and description

- Exceptional flatness
- Broadband from 0.01 to 50 GHz
- Extremely temperature stable
- Environmentally rugged

The 8474 series of coaxial detectors are specifically designed for use in microwave instrumentation and systems. These detectors utilize a GaAs diode matched to a 50 ohm transmission line with a miniature thin film circuit.

The diodes are a Planar-Doped Barrier (PDB) structure fabricated by use of Molecular Beam Epitaxy technology. This combination yields a device which has superior characteristics to point-contact and low-barrier Schottky devices. These characteristics are reflected in frequency response specification and in square law response vs. frequency (Figure 7) with PDB detectors showing a maximum square law response variation of 3% from 2 to 18 GHz vs. 9.5% for Schottky detectors.

These detectors are extremely rugged with high resistance to ESD damage and are less sensitive to temperature change than either point-contact or Schottky diodes. These products offer 10 MHz to 50 GHz performance with the 2.4 mm connector (8474E) or narrower frequency coverage with APC-7 Type N or SMA-compatible 3.5 mm and 2.92 mm connectors. There is no need to order matched pairs because the frequency tracking is better than the original matched pair specifications.

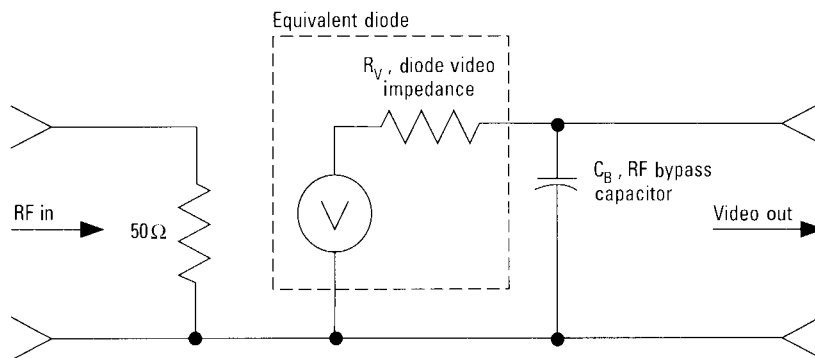

Figure 1. Equivalent circuit for 8474A/B/C/D/E with typical parameters

Typical values:

$R_V$  (diode video impedance)  $\approx 1.5 \text{ k}\Omega^*$

$C_B$  (RF bypass capacitor)  $\approx 27 \text{ pF}$  nominal

$$TR \text{ (10 to 90\% risetime)} \approx 2.2 \frac{(R_{LOAD}) (R_V)}{R_{LOAD} + R_V} (C_B + C_{LOAD}) = \frac{0.35}{BW}$$

\*@ 25 ° C and PIN  $\leq 20 \text{ dBm}$  (see Figure 7)

# Detector performance characteristics

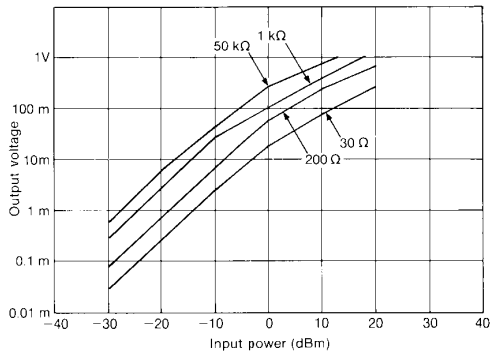

Figure 2. Typical transfer characteristics ( $T_a = 25^\circ \text{C}$ ).

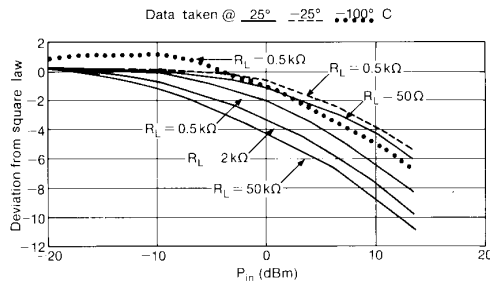

Figure 3. Typical square law deviation.

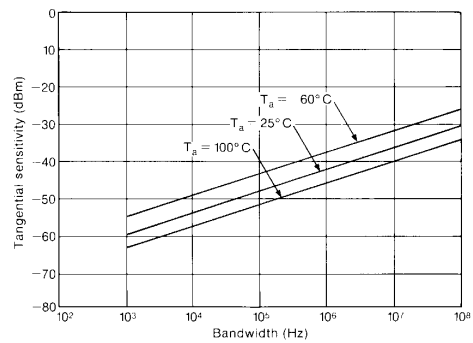

Figure 4. Typical tangential sensitivity.

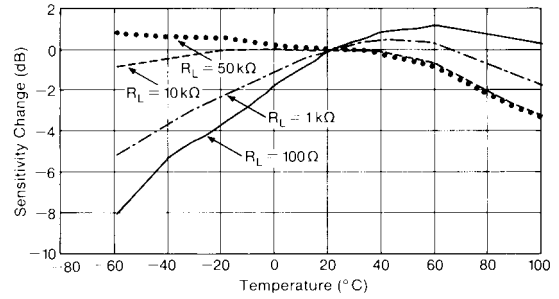

Figure 5. Typical output response with temperature. ( $P_{in} \leq 20 \text{ dBm}$ )

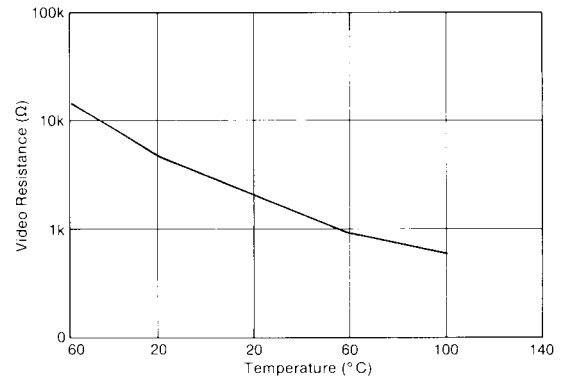

Figure 6. Typical video impedance variation with temperature.

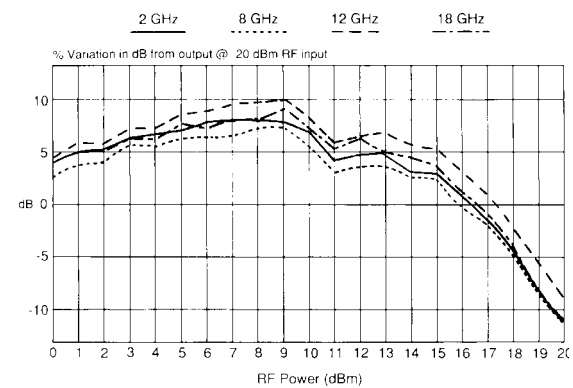

Figure 7. Typical square law deviation due to frequency.

## Specifications

	<b>8474B</b>	<b>8474C</b>	<b>8474E</b>
Frequency range:	0.01-18 GHz	0.01-33 GHz	0.01-50 GHz
Frequency response	±0.35 dB	±0.45 dB from 0.01 to 26.5 GHz	±0.4 dB from 0.01 to 26.5 GHz
		±0.7 dB from 26.5 to 33 GHz	±0.6 dB from 26.5 to 40 GHz
			±1.0 dB from 40 to 50 GHz
SWR:	<1.3	<1.4 .01- 26.5 GHz <2.2 26.5- 33 GHz	<1.2 .01- 26.5 GHz <1.6 26.5- 40GHz <2.8 40-50 GHz
Low-level sensitivity:	>0.4 mV/μW	>0.4 mV/μW	>0.4 mV/μW  >0.34 mV/μW 40-50 GHz
Max. operating inputs:	200 mW	200 mW	200 mW
Typical short- Term max. input:	0.75 watt (<1 min.)	0.75 watt (<1 min.)	0.75 watt (<1 min.)
Noise: (μV peak-to-peak with CW power applied to produce 100 MV output, 400 kHz BW)	<50 μV	<50 μV	<50 μV
STD output polarity:	negative	negative	negative

Note: Above specifications are at 25° C and ≤20 dBm unless otherwise specified.

## Mechanical information

	<b>8474B</b>	<b>8474C</b>	<b>8474E</b>
Dimensions	20.82 (0.82)	7.9 (0.31)	7.9 (0.31)
mm (inches)	59.86 (2.36)	41.15 (1.62)	37.36 (1.47)
	18.68 (0.74)	9.7 (0.38)	7.6 (0.30)
Input connector:	Type N (m)	3.5 mm (m) SMA compatible	2.4 mm (m) 1.85 min compatible
Output connector:	BNC (f)	SMC (m)	SMC (m)
Net weight:	85.3 grams (3 oz.)	13.9 grams (0.49 oz.)	9.1 grams (0.32 oz.)

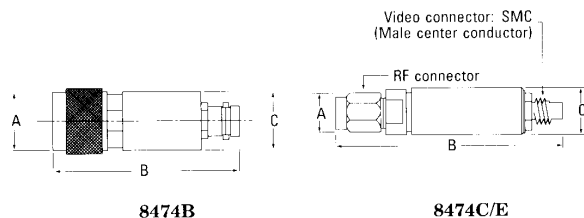

<b>8474B Options</b>	<b>002</b>	<b>004</b>	<b>008</b>	<b>012</b>	<b>018</b>	
Frequency range (GHz):	.01-2	2-4	4-8	8-12.4	12.4-18	
Frequency response (dB):	±0.25	±0.25	±0.25	±0.25	±0.35	
SWR:	<1.09	<1.1	<1.2	<1.3	<1.31	
<b>8474C Options</b>	<b>004</b>	<b>008</b>	<b>012</b>	<b>018</b>	<b>026</b>	<b>033</b>
Frequency range (GHz):	2-4	4-8	8-12.4	12.4-18	18-26.5	26.5-33
Frequency response (dB):	±0.2	±0.2	±0.25	±0.3	±0.3	±0.3
SWR:	<1.1	<1.16	<1.2	<1.3	<1.41	<2.2

## Environmental

**\*Operating temperature:** -65 to 100° C

**Temperature cycling (non-operating):** MIL-STD 883, method 1010.1:  
(-65 to 100° C)

**Vibration:** MIL-STD 883, method 2007: (0.6" D.A. 20 to 80 Hz, 20g, 80 to 200 Hz)

**Shock:** MIL-STD 883, method 2002.1: (500g, 0.5 msec)

**Acceleration:** MIL-STD 883, method 2001: (500g)

**Altitude:** MIL-STD 883, method 1001: (50,000 ft, 15,240 m)

**Salt atmosphere:** MIL-STD 883, method 1009.1: (48 hr, 5% solution)

**Moisture resistance:** MIL-STD 883, method 1004.1: (25 to 40° C, 95% RH)

**RFI:** MIL-STD 461B

**ESD:** 10 hits at 25kV to the body, not the center conductor.

[www.agilent.com](http://www.agilent.com)

For more information on Agilent Technologies' products, applications or services, please contact your local Agilent office. The complete list is available at: [www.agilent.com/find/contactus](http://www.agilent.com/find/contactus)

### Phone or Fax

#### United States:

(tel) 800 829 4444

(fax) 800 829 4433

#### Canada:

(tel) 877 894 4414

(fax) 800 746 4866

#### China:

(tel) 800 810 0189

(fax) 800 820 2816

#### Europe:

(tel) 31 20 547 2111

#### Japan:

(tel) (81) 426 56 7832

(fax) (81) 426 56 7840

#### Korea:

(tel) (080) 769 0800

(fax) (080)769 0900

#### Latin America:

(tel) (305) 269 7500

#### Taiwan:

(tel) 0800 047 866

(fax) 0800 286 331

#### Other Asia Pacific Countries:

(tel) (65) 6375 8100

(fax) (65) 6755 0042

Email: [tm\\_ap@agilent.com](mailto:tm_ap@agilent.com)

Contacts revised: 05/27/05

Product specifications and descriptions in this document subject to change without notice.

Copyright © 2001, 2006  
Agilent Technologies, Inc.  
Printed in U.S.A. May 30, 2006  
5952-0801

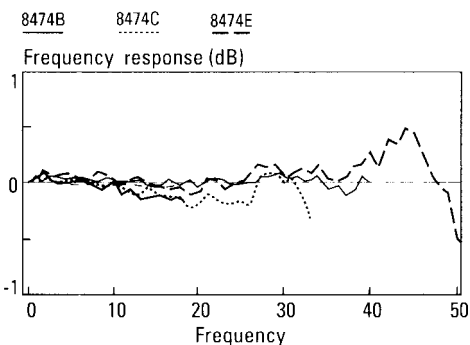

**Figure 8. Typical frequency response.**

\* 8474A/B specified for 0° C - 75° C.



**Agilent Technologies**